

VARIABLE FREQUENCY DRIVES



Practical Guide to Variable Frequency Drives (VFD)

Variable Frequency Drives Handbook

TABLE OF CONTENTS

Chapter 1

AC Motor Control Introduction	4
Types of Motors and Motor Control	5

Chapter 2

AC Motor Control Basics	6
Across-the-Line Starter	7
Soft Starter	7
VFD	8
Choosing the Right AC Motor Control	8

Chapter 3

VFD Details	9
VFD Application Characteristics	9
Constant Torque (CT)	9
Variable Torque (VT)	10
VFD Electrical Characteristics	10
System Voltage	10
Motor Full Load Amperage (FLA) and Overload	10
Environmental	10
VFD Classes	11
Micro	11
General Purpose	12
High-Performance	13
Washdown NEMA 4X	14
VFD Control Modes	14
Speed Control	14
Volts per Hertz (Volts/Hertz or V/Hz)	14
Sensorless Vector (SV)	15
Closed-Loop Flux Vector	15
Torque Control	15
Multi-Motor Modes	17
Primary/Follower Speed Matching	17
Primary/Follower Torque Matching	17
Multi-Motor	17
Dynamic Braking	17
Feedback Devices, Encoders	18

Jump to Chapter 

Chapter 1
AC Motor Drive
Introduction

Chapter 2
AC Motor Control
Basics

Chapter 3
VFD Details

Chapter 4
Common Design and
Application Errors

Chapter 5
VFD Selection

Monitoring and Control Connectivity and Communications.....	18
Communication Basics	18
Hardwired I/O.....	18
Pulse Train Output (PTO).....	19
Serial: ASCII and Modbus.....	19
Ethernet: Modbus TCP, EtherNet/IP, and BAC net.....	19
Other VFD Details	20
Keypads.....	20
Proportional/Integral/Derivative (PID) Control.....	20
Safety Functions.....	20
Built-In PLC.....	21
Energy Savings	21
Power Quality.....	22
Configuration, Monitoring, and Troubleshooting Software	22
Other Accessories	23
Chapter 4	
Common Design and Application Errors.....	24
Improper Sizing	24
Improper Cooling and Ventilation.....	24
Lack of Dynamic Braking.....	24
Communication Issues	24
Ground Fault Errors	25
Improper Line Voltage	25
Poor PID Tuning or Control Logic.....	25
Chapter 5	
VFD Selection	26

Jump to Chapter 

Chapter 1
AC Motor Drive
Introduction

Chapter 2
AC Motor Control
Basics

Chapter 3
VFD Details

Chapter 4
Common Design and
Application Errors

Chapter 5
VFD Selection

AC Motor Control Introduction

Almost every conceivable industrial machinery or equipment application requires creating and controlling some type of physical motion. Pneumatics provide a capable and cost-effective approach, while hydraulics meet the need when exceptional force is required. However, when all aspects of speed, power, durability, accuracy, and operating costs are considered in balance, the most common motive force is usually an electric motor.

Electric motors are the workhorses of modern industry because they excel at translating electrical energy into mechanical energy. They mostly operate in a rotational fashion, but they can be easily coupled to a wide range of mechanisms to produce the desired result.



Every motor requires an upstream device to control the flow of electricity, whether for basic on/off operation, advanced soft starting, or controlling speed and torque. This eBook explains the fundamentals of on/off starting mechanisms and then provides a deeper exploration of achieving effective electric motor control using variable frequency drives (VFDs). VFDs are sometimes referred to as variable speed drives (VSDs), AC drives, or occasionally as inverters due to one of the major components within a VFD.

Jump to Chapter

Chapter 1
AC Motor Drive Introduction

Chapter 2
AC Motor Control Basics

Chapter 3
VFD Details

Chapter 4
Common Design and Application Errors

Chapter 5
VFD Selection

Jump to
Chapter**Chapter 1**
AC Motor Drive
Introduction**Chapter 2**
AC Motor Control
Basics**Chapter 3**
VFD Details**Chapter 4**
Common Design and
Application Errors**Chapter 5**
VFD Selection

Types of Motors and Motor Control

The earliest practical electric motors were direct-current (DC) motors, first conceived in the mid-1800s. By the late 1800s, alternating-current (AC) motors were also developed. Both AC and DC motors are easily operated in an on/off mode at their full rated speed, but for many years, it was only possible to control the speed of DC motors, which was done by varying the voltage. In fact, it was not until the mid-1900s and beyond that AC motor speed control was possible through the development of the first VFDs.

There are some trade-offs between the two. While DC motors can produce nearly full torque even at very low speeds, the early versions of AC motor VFDs were not capable of this, and they sometimes could not operate motors at speeds low enough for a given application. However, more recent VFD technological developments, such as digital-based controllers and vector control, have significantly expanded the capabilities of AC motor speed control, making them suitable for many types of applications.

Today, both AC induction and DC motors are options for on/off operation, whether at a fixed speed or under control at variable speeds. However, AC motors tend to be more widely used throughout industry—when their specifications meet design requirements—because of their high efficiency, lower maintenance, and overall cost-effectiveness.

While standard DC motors—and indeed other motor variants such as servo motors and stepper motors—play an important role in many designs, this eBook describes the products and technologies designers should become familiar with as they incorporate VFD controls for AC motors.

AC Motor Control Basics

Every AC motor, whether it is commanded to run by a local pushbutton or by HMI and PLC control, requires certain elements to control its operation. Driven loads include pumps, fans, conveyors, and more.



There are many different motor types and form factors, which are governed by NEMA or IEC standards. Motors are typically rated according to:

- Nominal voltage, frequency, and single- or three-phase design.
- Operating speed in rotations per minute (rpm).
- Horsepower produced.
- Full load amps (FLA) at rated horsepower.
- Efficiency.

[Follow this link to the AutomationDirect AC Motors Handbook to find out more.](#)

Industrial AC motors are commonly rated 1,200, 1,800, or 3,600 rpms at base speed, but other full speeds are possible. In fact, sometimes a motor may actually be operated above its full rated speed using a VFD when certain precautions are observed.

If a motor is controlled using a basic across-the-line starter, it will typically draw 6 to 10 times the FLA during the brief startup periods, so the control method must accommodate this.

Three of the most common AC motor control methods are:

- Across-the-line starter: For basic on/off control.
- Soft starter: smoothly accelerates on startup to minimize inrush current, and performs controlled starting and stopping to reduce wear and tear on the driven load.
- VFD: Enables complete motor speed control and enhanced monitoring.

The following are some details about each of these common AC motor control methods.

Jump to Chapter

Chapter 1
AC Motor Drive
Introduction

Chapter 2
AC Motor Control
Basics

Chapter 3
VFD Details

Chapter 4
Common Design and
Application Errors

Chapter 5
VFD Selection

Across-the-Line Starter

[Across-the-line motor starter control](#) applies full voltage and current to a motor when the circuit is energized. Typically, a complete motor starter scheme consists of a contactor to open or close the flow of electricity to the motor, in conjunction with an overcurrent protective device (OCPD) to protect against short-circuit events, as well as an electronic or thermal overload device to protect against motor overloading conditions. A contactor is an electromechanical switch that must withstand the inrush and running current of the motor when closed and be able to open when the motor must stop. A properly wired pair of across-the-line starters can be used to run the motor forward or reverse to suit the application.

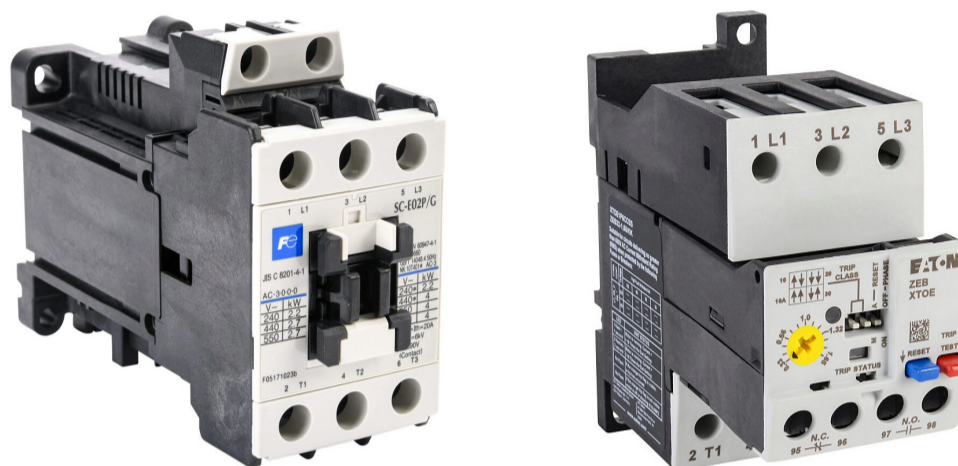

Across-the-line motor starting is used when the application can run at the motor's rated rpm and where speed and voltage sags/spikes do not pose a problem. Motor starters are commonly used with smaller motors when the electrical and mechanical softening effects of a soft starter are not needed.

Soft Starter

A [soft starter](#) is a solid-state electronic device with digital controls and thyristors for power handling. These devices modulate the voltage applied to the motor during startup to control the current and torque, which in turn allows the motor to ramp up smoothly to speed. Once at full speed, a bypass contactor operates for maximum efficiency. Motor torque is proportional to the square of the applied voltage, and motor current during starting is directly related to the applied voltage. Some modern soft starters provide many advanced controls and communication options similar to a VFD.



Soft starters are used to reduce the motor inrush current, along with moderating mechanical shock to the motor and downstream machinery. While soft starters are useful for all motor sizes, they are even more important for large motors, which would otherwise draw massive current if started across-the-line and potentially incur penalty demand charges from the electrical utility if the spikes occur at certain times of day.

Jump to
Chapter



Chapter 1

AC Motor Drive
Introduction

Chapter 2

AC Motor Control
Basics

Chapter 3

VFD Details

Chapter 4

Common Design and
Application Errors

Chapter 5

VFD Selection

VFD

VFDs, like soft starters, are solid-state electronic devices with digital controls. However, VFDs have many other extended capabilities. A VFD controls motor speed and torque by adjusting both the voltage and the frequency of three-phase power supplied to an AC motor. It accomplishes this by first converting the AC line voltage supplied to a VFD into a smooth DC voltage, which is then used by an insulated-gate bipolar transistor (IGBT) inverter to generate the proper simulated AC voltage levels. This result is known as a pulse-width-modulated (PWM) waveform. The majority of VFDs are 6-pulse, but 12- and 18-pulse VFDs exist and achieve better harmonic performance to meet electrical standards and regulations.

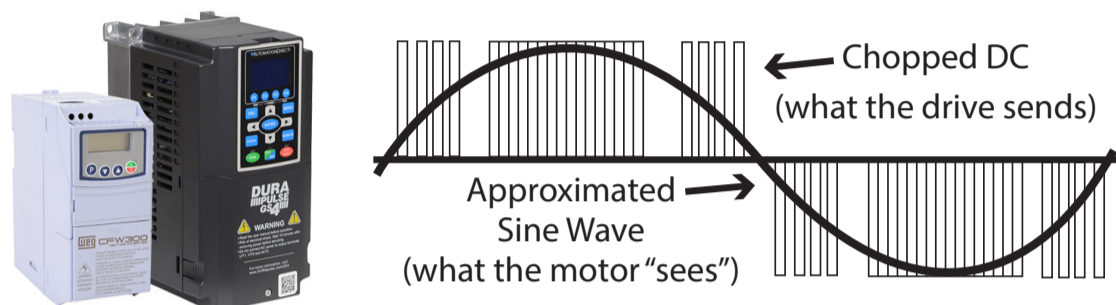

Basic VFD functions include overload protection, start/stop control, and adjustable acceleration/deceleration. Many other advanced capabilities are available, such as current limiting to reduce motor inrush current at startup, advanced control modes, additional input/output (I/O) connections, digital communications with supervisory systems, PID loop control, on-board programmable logic controller (PLC) control, and more.

Choosing the Right AC Motor Control

For most single-phase AC motors, the only control options are across-the-line and soft starters. There are some specialized single-phase motors that can be controlled with a variable speed drive (but not a variable frequency drive), but that is a different topic.

All 3-phase motors today are “inverter duty” and can be used with a VFD. If operation at very low speeds or very high loads is needed, best practice is to use a high-performance inverter rated motor. Some specialized motors, such as permanent magnet AC (PMAC) motors, can only be controlled with a VFD.

When it comes to motors, there are three common enclosure types, which impact what types of environments the motor can be installed and how it is cooled:

- Open Drip Proof (ODP) motors are open frame, with ventilation openings designed to prevent ingress from falling solids or liquids. They are intended for indoor applications in clean environments.
- Totally enclosed fan-cooled (TEFC) motors have no ventilation openings (although the motor is not air- or liquid-tight) and have a fan attached to the rear of the motor shaft to help cool the motor. They can operate at higher ambient temperatures without overheating, but there may be a certain minimum speed to effectively cool the motor in VFD applications.
- Totally enclosed non-ventilated (TENV) motors are not air- or liquid-tight and do not have a fan, as they are designed to cool by convection.

Regardless of the AC motor type, across-the-line starting generally has the lowest initial cost, but the highest operating cost. Soft starter design is typically less expensive than VFDs for larger motors, though lower horsepower applications can be very similar in price. VFDs have the highest initial cost, but can provide the lowest operating cost. The latter two options provide worthwhile long-term benefits for protecting, monitoring, and controlling equipment.

The remaining majority of this eBook focuses on VFD control of AC motors. VFDs are used where speed control is essential, energy efficiency is important, and other advanced features may be useful. The following sections provide greater detail to help designers and specifiers with VFD selection.

Jump to Chapter



Chapter 1
AC Motor Drive
Introduction

Chapter 2
AC Motor Control
Basics

Chapter 3
VFD Details

Chapter 4
Common Design and
Application Errors

Chapter 5
VFD Selection

VFD Details

When specifying a VFD, it is important to understand the mechanical equipment and motor electrical characteristics, and what degree of control functionality is needed. There are a few classes of VFDs, with increasingly capable feature sets, and a VFD data sheet provides all the details.

1-800-633-0405 For the latest prices, please check AutomationDirect.com.

DURAPULSE GS30 AC Drives – Introduction



		1/2	1	2	3	5	7.5	10	15	20	25	30	40	50	60	75	100	
Motor Rating		HP	1/2	1	2	3	5	7.5	10	15	20	25	30	40	50	60	75	100
		kW	0.4	0.75	1.5	2.2	3.7	5.5	7.5	11	15	18.5	22	30	37	45	55	75
230V	Single-phase	✓	✓	✓	✓	✓	✓	✓	✓	✓	✓	✓	✓	✓	✓	✓	✓	✓
230V	Three-phase	✓	✓	✓	✓	✓	✓	✓	✓	✓	✓	✓	✓	✓	✓	✓	✓	✓
480V	Three-phase	✓	✓	✓	✓	✓	✓	✓	✓	✓	✓	✓	✓	✓	✓	✓	✓	✓

✓ = GS30 model available

Overview

The DURApulse GS30 high performance flux-vector drives provide advanced drive functionality—all in a compact unit that has been reduced 40% in size compared to its predecessor.

These new drives include the same standard features as our GS family of drives: dynamic braking, built-in PID control, removable keypad, and RS-485 Modbus communication.

The GS30 drive expands the DURApulse family by adding internal tension control loop expanded parameter sets for greater versatility. Optional EtherCAT® and single- or dual-port EtherNet/IP communication cards. Support for up to four (4) independent IM motor parameter sets or control of a single AC PM motor.

DURApulse GS30 AC drives offer several control modes for induction or permanent magnet AC motors. Standard V/Hz and sensorless vector (SVC) modes provide quick setup and control. Field Oriented Vector control (FOC) provides high precision open loop control. For full closed loop vector control, FOCV provides 1:1000 precision. Torque control mode, with open or closed loop control, is also available.

DURApulse GS30 offers two analog inputs, one analog output, seven digital inputs (including one pulse train input up to 3kHz), two digital outputs, one SPT relay output, and two STO inputs. All of the analog and digital I/O can be configured for a wide variety of input or output functions. Two option card slots are available on all models so you can add additional I/O AND a communication card or backup power supply. This provides greater flexibility to equip the new GS30 to your specific needs.

Features

- Broad offering from 1/2 to 100 hp
- Single-phase 230VAC up to 3HP
- Three-phase 230VAC up to 50hp and 460VAC up to 100hp
- Dual rating design – CT/VT Ratings
- “Zero Slack” side-by-side zero gap installation
- Compact Design
- Advanced LCD keypad with parameter descriptions
- Spring clamp terminal blocks
- Quick setting wheel dial for quick speed changes and parameter scrolling
- Flexible carrier frequency to 15kHz and output frequency to 599.0 Hz
- STO – Safe Torque Off (TUV Certified)
- Built-in PLC to support up to 5K steps
- Built-in USB port for fast & easy programming
- Free downloadable software for drive configuration and PLC programming
- Field-upgradable firmware (drive & communication option cards)
- Local/Remote control mode selection or digital/comm input with Hand/Off/Auto control
- Display custom values/units on keypad
- Momentary power loss restarts
- 100KA Short Circuit Current Rating (Frames A-F)
- DC Bus Connection Terminals
- Analog I/O – configurable 2 Inputs and 1 Output
- Multi-Motor Control (4 total)
- Built-in Dynamic Braking (up to 30hp@230VAC, 40hp@460VAC) – optional resistors
- PID Controller – including sleep and wake
- Password protection
- RTD and/or PTC input motor protection
- Modularized design eases maintenance and expansion, including quick replacement of cooling fan
- High speed communication interfaces with MODBUS RTU built in, plus optional cards with additional interface types
- Circuit boards have conformal coating for improved environmental tolerance
- Excellent heat sink design; able to operate at 50°C ambient temperature
- Fire Mode – Run fire mode during emergencies to have uninterrupted smoke

Accessories

- AC line reactors
- dV/dt output filters
- EMI filters
- RF filter
- Braking resistors
- Fuses
- NEMA 1 Conduit boxes
- DIN rail mounting kits for drives up to 5hp
- Replacement cooling fans
- Replacement keypad
- Optional advanced LCD keypad (and remote-mount bezel kit)
- GS302 drive configuration software
- GSLogic PLC programming software
- Type A to B USB cable
- Detailed descriptions and specifications for GS30 accessories are available in the “GS30 DURApulse Accessories” section.

Typical Applications

- Conveyors
- Compressors
- Material handling
- Extruding
- Grinding
- Shop tools
- Fans
- Pumps
- HVAC
- Mixing
- Unwinding
- Rewinding

AC Drives tGSX-39

Jump to Chapter 

- Chapter 1**
AC Motor Drive Introduction
- Chapter 2**
AC Motor Control Basics
- Chapter 3**
VFD Details
- Chapter 4**
Common Design and Application Errors
- Chapter 5**
VFD Selection

VFD Application Characteristics

The first step is to identify the load operating profile, which is generally one of these two types:

Constant Torque (CT)

For constant torque (CT) applications, also referred to as Heavy Duty (HD), the motor must provide the same amount of torque to the load at all speeds from low to high, with power delivery increasing linearly with speed. Common examples are conveyors, compressors, positive displacement pumps, mixers, and extruders.

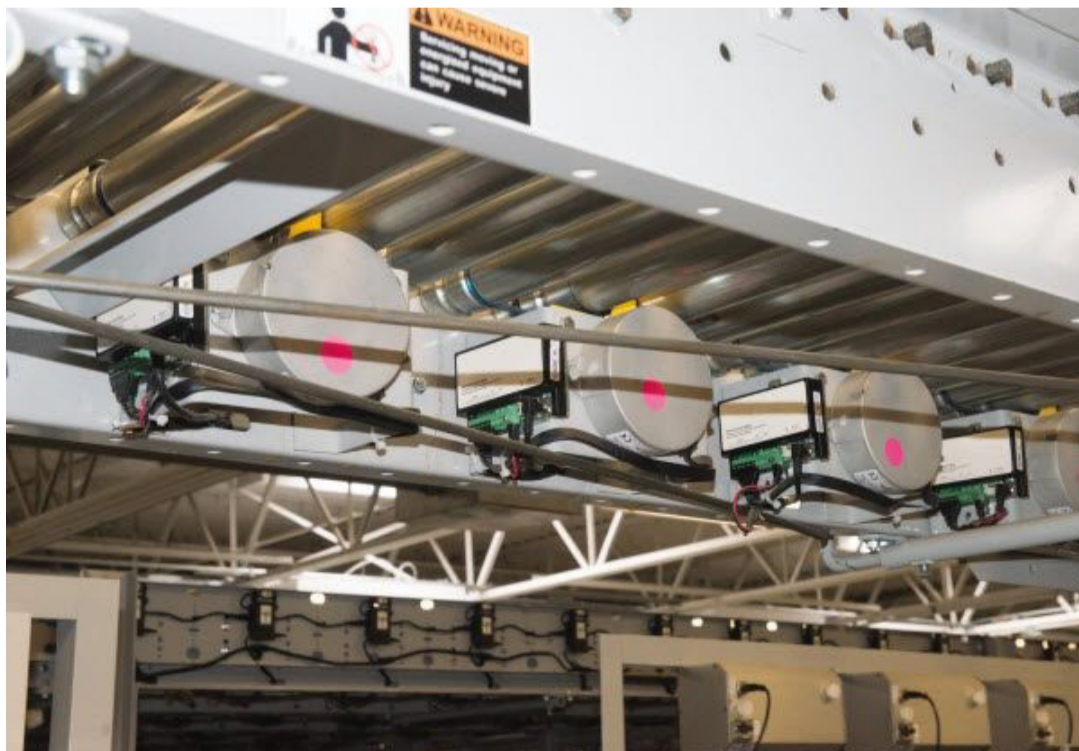

Variable Torque (VT)

For variable torque (VT) applications, also referred to as Normal Duty (ND), the torque required by the load varies with the operating speed, with the torque increasing as the square of speed, and power increasing as the cube of speed. Common examples are centrifugal pumps, fans, and blowers.



Note that VFDs commonly carry different ratings for use in either CT or VT applications, so the specifier must take care when selecting the drive. If unsure of the application type, choosing the CT rating is the more conservative design approach and will provide adequate power for either CT or VT applications.

VFD Electrical Characteristics

The second step is identifying the system voltage, motor nameplate requirements, and overload aspects.

System Voltage

Most VFDs are supplied with three-phase power, and they are always used with three-phase motors. The supply voltage must match the input voltage requirement of the VFD, and the drive's output voltage should match the motor's operating voltage. Additionally, there are VFDs specifically designed for single-phase input power, and certain three-phase drives can use single-phase supply power with appropriate derating.

Motor Full Load Amperage (FLA) and Overload

Full load amperage is the most important design specification. The motor nameplate identifies its full load current requirement, and the VFD should be sized to supply a current output at or above this value. Many applications may experience overload conditions upon startup or intermittently during operation. While most VFDs can operate at 150% overload for 60 seconds, more strenuous requirements demand VFD oversizing. A VFD can successfully operate a smaller motor well below the VFD rating, although there are limits. The conservative approach is to always choose a VFD capable of delivering more amperage than the nameplate motor amps. This provides plenty of "headroom" in case of unforeseen application changes and allows the VFD to operate at lower temperatures, which will prolong the life of the equipment.

Environmental

VFDs are electrical/electronic devices typically installed within enclosures to protect them from the environment. VFDs are rated to operate within a certain temperature range, and they generate significant heat as they operate. That heat must be transferred to the outside environment, and this process is impacted by the ambient temperature and potentially any additional heat from the sun (in outdoor installations). Altitude also plays a role in heat transfer performance. [AutomationDirect offers a sizing tool](#) to help specifiers account for overload, altitude, and ambient thermal conditions. There are VFDs that are suitable for mounting outside of enclosures and are often rated for NEMA 4X.

Jump to
Chapter



Chapter 1
AC Motor Drive
Introduction

Chapter 2
AC Motor Control
Basics

Chapter 3
VFD Details

Chapter 4
Common Design and
Application Errors

Chapter 5
VFD Selection

VFD Classes

From an electrical standpoint, a wide range of VFDs is available to drive AC motors from fractional horsepower up to several hundred horsepower or more. Similarly, various VFD product families offer differing technical features. In many cases, it is convenient to group VFDs into a few classes by size and feature set, described in the following sections.

Micro

Micro VFDs (microdrives) are traditionally a great choice when small speed adjustments are required in basic applications of about 10HP or less, such as low-torque conveyors or light-duty fans and pumps. New products in this VFD category now include generous I/O and many advanced features that can handle even more complex applications.

Some AC microdrive benefits include:

- **Small Footprint:** DIN rail- and panel-mount options fit into smaller panels distributed on machinery or enable installation of many devices in a larger panel.
- **Single-Phase Compatible:** Allows common residential/commercial single-phase power to operate 230VAC three-phase motors; useful in many machinery and equipment applications.
- **Flexible Connectivity:** Can be controlled by operator input using a keypad/knob or using hardwired control, and some models support digital PLC communications.
- **Advanced Features:** Modern microdrives even offer some features—such as dynamic braking, sensorless vector control, serial communications, and an integrated PLC—normally only found on higher-cost VFDs.

AutomationDirect offers the following micro AC VFD families:

- AutomationDirect DURApulse GS10
- IronHorse ACM and ES1
- WEG CFW100



Jump to
Chapter



Chapter 1
AC Motor Drive
Introduction

Chapter 2
AC Motor Control
Basics

Chapter 3
VFD Details

Chapter 4
Common Design and
Application Errors

Chapter 5
VFD Selection

General Purpose

[General-purpose AC Drives](#) occupy the “just right” zone for many applications, with more features and a larger selection of voltage and horsepower choices than AC microdrives, but at a lower cost than high-performance versions. In many cases, the main reason to choose a general purpose VFD over an AC microdrive is to handle motors from 10 to 30 hp. General purpose drives may also use option cards to add communications and other features and may include additional control modes such as torque control.

In fact, chances are strong that unless a higher horsepower rating—or some very specialized functionality like closed-loop flux vector control—is required, there is no need to move up to a high-performance VFD because a general purpose VFD will do the job while saving money. Some typical general purpose VFD applications include conveyors, pumps, fans, mixers, palletizers, HVAC systems, elevators, and compactors.

AutomationDirect offers the following general purpose AC VFD families:

- AutomationDirect DURApulse GS20
- IronHorse ACG
- WEG CFW320



Jump to
Chapter

Chapter 1
AC Motor Drive
Introduction

Chapter 2
AC Motor Control
Basics

Chapter 3
VFD Details

Chapter 4
Common Design and
Application Errors

Chapter 5
VFD Selection

High-Performance

[High-performance AC VFDs](#) are the answer when ultimate precision, performance, and horsepower range are needed. These VFDs offer more full-featured versions of capabilities found in lesser drives, and they also incorporate attributes not found in other drive classes. High-performance VFDs are used for high-speed brake-meter conveyor belts to achieve accurate product gapping, for winder/tensioner applications which may alternate between speed and torque control, and for large installations where many drives are networked together and closely coordinated.

- **Full Torque Throughout the Speed Range:** High-performance VFDs always support sensorless vector speed control (sometimes simply called vector speed control), which is an open-loop approach for providing full torque from the full motor speed down to low speeds. However, high-performance VFDs often support closed-loop flux vector speed control, which supports 100% torque from the full motor speed down to zero speed.
- **Torque Control:** While lesser drives may offer torque control, a high-performance VFD provides dedicated parameters for popular applications of this type, such as tension control.
- **Other Enhanced Features:** In a high-performance VFD, integrated PLC functionality is more powerful, more advanced networking capabilities are available, and other safety features—such as safe torque off (STO) and safe stop 1 (SS1), in accordance with IEC 60204-1—are often available.
- **Modularity:** A benefit of standardizing on one high-performance drive family is the reduced learning curve of using one software suite and parameter structure. This enhances configuration speed and accuracy, as well as MRO, spares, and plant-floor support through the product's life cycle.



AutomationDirect offers the following high-performance AC VFD families:

- AutomationDirect DURApulse GS30 and GS4
- Toshiba AS3
- WEG CFW500

Jump to
Chapter



Chapter 1
AC Motor Drive
Introduction

Chapter 2
AC Motor Control
Basics

Chapter 3
VFD Details

Chapter 4
Common Design and
Application Errors

Chapter 5
VFD Selection

Washdown NEMA 4X

[VFDs rated for washdown](#) and NEMA 4X service are not really a class of VFD, as these ratings are really features. However, they do occupy a unique and useful niche for many applications. Micro, general purpose, and high-performance options are available with washdown and NEMA 4X ratings.

While most VFDs must be installed in a protected electrical room or enclosure, a washdown NEMA 4X device is completely self-contained within its own enclosure, using materials and provisions for cooling and water/chemical resistance. Therefore, a washdown NEMA 4X VFD can be installed quite close to the motor it controls, providing operators with local visualization and interface options. This type of specialized VFD is commonly found in food and beverage and water/wastewater applications.



AutomationDirect offers the following washdown NEMA 4X AC VFD families:

- AutomationDirect DURApulse GS20X
- IronHorse ACN and ES1
- WEG CFW500

VFD Control Modes

During commissioning, every VFD requires entry of basic parameters, including motor voltage, rpm, and full load current. Depending on the application, users must also select the appropriate control mode and configure other features. Here are some common examples:

Speed Control

Many VFDs operate AC motors using basic speed control, sometimes called velocity control. Three common ways of doing so are as follows.

Volts per Hertz (Volts/Hertz or V/Hz)

V/Hz control, also called constant V/Hz or scalar control, is a traditional VFD open-loop control technology that simply varies the voltage and frequency applied to the motor in a linear manner. For example, to operate a 480VAC motor at 50% speed, the VFD would output 30Hz and 240VAC to the motor.

This is a straightforward and easy-to-implement control mode, but it does not include any feedback, so motor speeds are not exceptionally accurate and may slip under load. This approach delivers good speed and starting torque control, and it is often acceptable for loads with near-constant torque where rapid response and speed accuracy are not essential. Depending on manufacturer and model line, one VFD can drive many motors using this mode, and it works well for many applications like centrifugal pumps, fans, and material conveyors.

Jump to
Chapter



Chapter 1
AC Motor Drive
Introduction

Chapter 2
AC Motor Control
Basics

Chapter 3
VFD Details

Chapter 4
Common Design and
Application Errors

Chapter 5
VFD Selection

Sensorless Vector (SV)

SV control is termed “sensorless” because there is no dedicated external sensor, but the VFD does actively monitor the voltage and current of the connected motor to mathematically determine the speed with sufficient accuracy. Using this information, the VFD can operate in a “virtual” closed-loop mode and deliver higher starting torque and accurate speed control under varying loads, as low as 1% of base speed and up to 200% of rated torque for brief periods, depending on the application.

This mode is available on most drive classes, and it is best for applications where high accuracy is required, such as printing lines and textile manufacturing, but only one motor can be connected to a VFD in this mode.

Closed-Loop Flux Vector

Closed-loop flux vector control is similar to SV control, but is greatly improved by the addition of an encoder to the motor shaft. This speed sensor is wired to the VFD to provide precise velocity feedback, enabling closed-loop control, which allows 100% holding torque to be developed at zero speed.

Flux vector mode allows AC motors to deliver exceptional speed control, even in variable torque conditions, for demanding applications.

Torque Control

In many cases, the primary operational concern for an AC electrical motor is speed control. However, there is another class of applications where torque control is the primary goal. Torque control requires a VFD, and it differs from speed control because the primary goal is to operate the motor at a commanded torque, regardless of the resulting speed. VFDs operating in torque mode modulate the power and speed to achieve a commanded torque. Torque control was formerly available almost solely as a high-end VFD feature, but it is now present on many mid-level VFD models.

A VFD with sensorless vector control can operate in torque control mode, but those with closed-loop feedback control perform even better. Torque control mode necessitates additional configuration steps, requiring the user to initiate a “dynamic tuning” of the bare motor, without any pulleys or other mechanical components attached. The VFD will spin and stop the motor, energizing it in various ways to determine electrical characteristics such as:

- No load current, in amps.
- Stator resistance, in ohms.
- Rotor resistance, in ohms.
- Magnetizing inductance, in microhenries (μH).
- Stator inductance, in μH .

At this point, the VFD has all the information it needs to operate the motor to produce a commanded torque. Speed limiting is a key feature of torque control because if there is insufficient equipment loading to meet the torque setpoint, the drive would otherwise quickly accelerate the motor to maximum speed. Utilizing the speed limitation parameters is important to ensure the motor speed does not run away.

Jump to
Chapter



Chapter 1

AC Motor Drive
Introduction

Chapter 2

AC Motor Control
Basics

Chapter 3

VFD Details

Chapter 4

Common Design and
Application Errors

Chapter 5

VFD Selection

There are other potential applications for torque control, such as with material handling equipment, where a designer must ensure the mechanical components only experience a finite amount of force, regardless of how the equipment is loaded. It is even possible in certain arrangements for a motor to be energized, yet hold a load in a fixed position with just the right amount of torque, without any motion one way or the other.

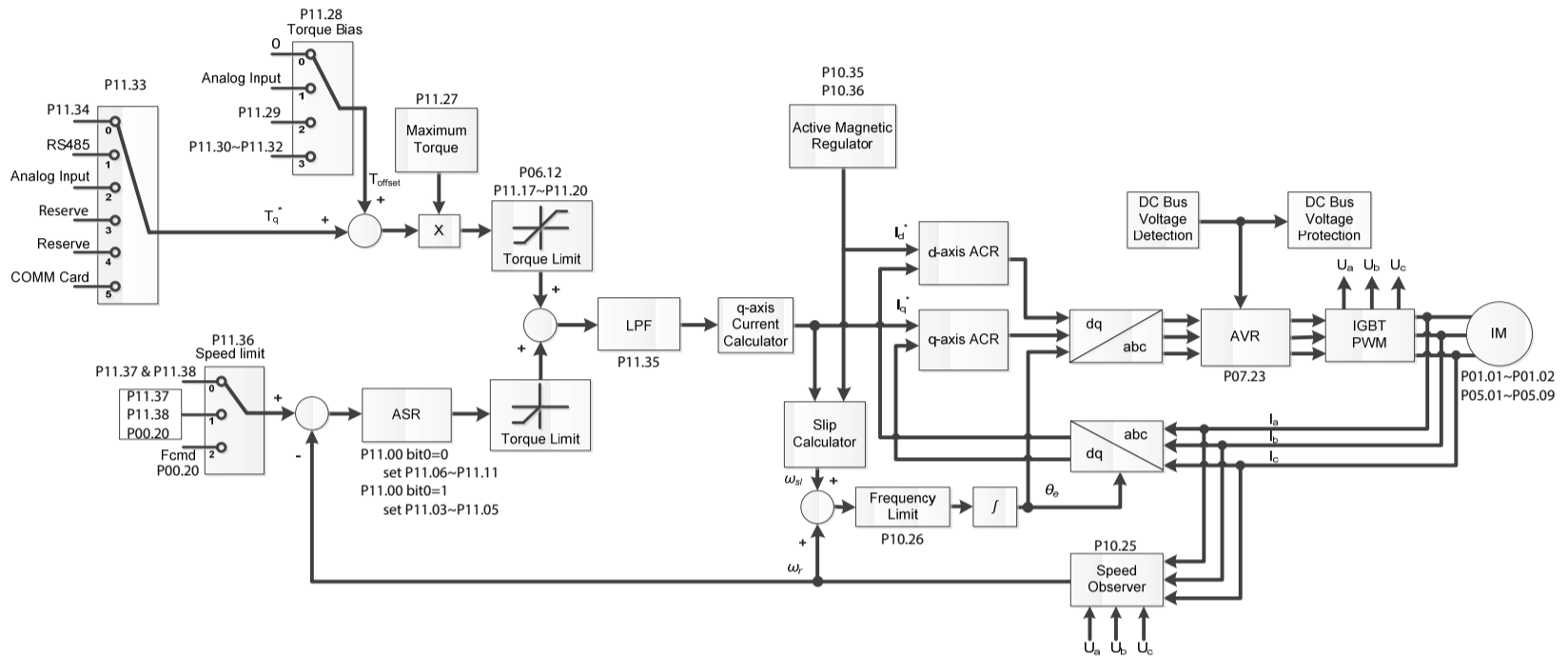

Example of a torque control function block diagram.

Jump to Chapter

Chapter 1
AC Motor Drive Introduction

Chapter 2
AC Motor Control Basics

Chapter 3
VFD Details

Chapter 4
Common Design and Application Errors

Chapter 5
VFD Selection

Applications for torque control span many industries. Textile processors must wind and unwind rolls of wovens and webs with constant tension. The same goes for the pulp and paper industry, and one can imagine how precise the rolling and unrolling balance must be for delicate products like toilet paper. Even in the metals industries, where flat rolls and wire rolls of steel and other strong materials are the focus, the tension must be carefully maintained. Torque control overcomes the challenge of constantly changing spool diameters as winding/unwinding proceeds. Some high-performance VFDs have built-in tension control and can operate independently of a PLC or other control system.



Multi-Motor Modes

Some mechanical systems use multiple motors and can benefit from one or more VFDs controlling them in a coordinated manner. More capable VFDs offer some or all of these modes. A few examples:

- A blending system with multiple pumps may need “follower” motors to run at a ratio of the “primary” motor speed.
- Long conveyors may use multiple AC motors connected along the equipment to distribute the applied force evenly.
- A pumping system may have one primary pump sized for the normal load and additional supplementary pumps that need to operate in high-flow conditions.

Various VFD multi-motor modes can provide effective solutions for each case.

Primary/Follower Speed Matching

One VFD can be configured as primary, with additional VFDs set up as followers, with all followers interconnected. When the primary VFD is commanded to operate a motor at a speed, the follower VFDs each run at a designated (but adjustable) ratio of the primary speed. This is also called rate mode.

Primary/Follower Torque Matching

In the case of multiple VFD-driven motors connected to a single piece of equipment, such as a conveyor, the VFDs can be configured to share the load (torque) evenly. All the VFDs are interconnected, and they are commanded to operate at a speed. Using the connection among them, the VFDs each operate to produce an equal torque.

Multi-Motor

For an application with multiple pumps, there are three different basic multi-motor approaches.

- **Time Circulation Mode:** A single VFD can control up to 8 motors, one at a time, sequentially cycling through them (by operating contactors) to evenly distribute the run time and wear. This is an economical way to introduce redundancy into a system. The total number of motors a VFD can control varies by manufacturer and model.
- **Quantity Control:** A single VFD can control one motor, where the equipment is sized to meet the normal demand. If demand increases beyond this point, the VFD can call for up to 8 additional across-the-line driven motors to run (by operating contactors from the drive's I/O), bringing them online one at a time as needed to meet the demand.
- **Quantity Cycle:** This is similar to quantity control, but the additional motors are VFD-driven, providing additional flexibility.

Dynamic Braking

When an AC motor is quickly slowed down by a VFD, or the driven equipment otherwise is moving faster than the VFD speed command, the motor effectively becomes a generator and feeds energy back into the VFD, which must compensate. Dynamic braking is a method used to dissipate this excess energy so that the load can be slowed or stopped effectively and rapidly without requiring external mechanical braking systems. Dynamic braking is achieved by a braking chopper, which directs the excess energy into a braking resistor, dissipating it as heat.

Dynamic braking is beneficial for equipment with frequent or rapid braking operations, especially when moving heavy loads. Equipment examples include fans, certain conveyors, cranes, and centrifuges, where rapid slowdown is often desired.

Jump to
Chapter



Chapter 1
AC Motor Drive
Introduction

Chapter 2
AC Motor Control
Basics

Chapter 3
VFD Details

Chapter 4
Common Design and
Application Errors

Chapter 5
VFD Selection

Feedback Devices, Encoders

As indicated in previous sections, the best VFD control of AC motors is achieved when a feedback device transmits the exact motor speed to the VFD. These systems most commonly use a rotary encoder as the sensor for detecting motor speed. Encoders are high-resolution position detection instruments. Typically, these are optical-based, generating pulses during rotary motion. A two-channel encoder—also called quadrature, “times 4”, or “x4”—uses two output channels, oriented 90 degrees apart from each other. Since there are multiple transitions of high and low pulses, the device reading these two-channel encoders can actually determine four times the number of positions of a one-channel encoder. Therefore, a two-channel encoder rated at 100 PPR would have a rating of 400 counts per revolution (CPR); this style is commonly used with AC VFDs.



Monitoring and Control Connectivity and Communications

The VFD narrative up to this point has barely touched on an extremely important differentiator among platforms and solutions: control communications. Higher-performance systems offer more capable communications capabilities, and various digital protocols offer extensive advantages over traditional hardwired methods.

Communication Basics

Most VFDs can operate without network control. Using the built-in faceplate to start, stop, and change the speed of the drive. However, for applications beyond one stand-alone VFD, hard-wired interfaces to a controller source, such as a PLC or network communications on a control system, are the solution.

Hardwired I/O

Hardwired I/O is the most basic form of motion monitoring and control communications, and many VFDs are provisioned with multiple discrete and analog inputs and outputs for this purpose. A PLC or other control system can provide a single discrete output signal to a VFD as a run command and an analog output as a speed command. Feedback signals are available for the PLC to monitor, including running status, speed, amps, faults, and more.

Jump to
Chapter



Chapter 1
AC Motor Drive
Introduction

Chapter 2
AC Motor Control
Basics

Chapter 3
VFD Details

Chapter 4
Common Design and
Application Errors

Chapter 5
VFD Selection

Pulse Train Output (PTO)

PTO signals—possible with many PLCs, including those from AutomationDirect—provide a more advanced form of I/O for speed signals. Pulse signals to command a drive are discrete outputs, capable of being cycled on/off at very high frequencies.

The most common PTO version is “pulse and direction,” where one output from the controller pulses rapidly to command small increments of motion, while a second output dictates the direction of travel. Clockwise(CW)/counterclockwise(CCW) pulses are a second option, with one output commanding motion increments in one direction, and vice versa. A third option is an A/B quadrature encoder, which uses two output channels oriented 90 degrees apart from each other to provide four times the positional resolution.

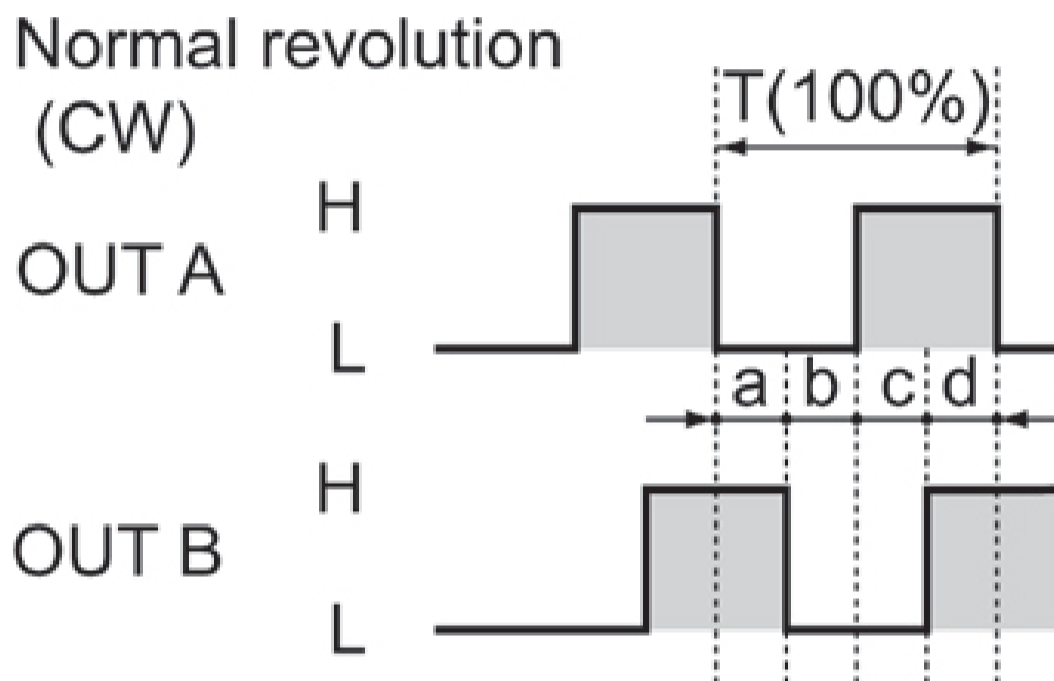

Example of a Pulse Train Output waveform.

PTO is a well-established method of control, but it has limitations. The wiring can be complex, especially as the number of VFDs increases. Coordinated motion between VFDs is possible using PTO, as one drive or controller may be able to generate a PTO signal to another, but this is usually only feasible in applications with limited VFD counts.

Serial:

ASCII or Modbus serial connectivity (RS-232 or RS-485, depending on the drive model) is accepted by some VFDs. Streaming commands from a controller—usually a PLC—to a VFD using a serial protocol is an effective way to gain more functionality than using hardwired or PTO I/O. However, there are speed limits in serial communications to keep in mind.

Ethernet:

Ethernet media and protocols have developed over the years to work in a multitude of industrial applications. Specific Ethernet variants are reliably used as industrial communication fieldbuses for handling I/O, controller/PLC peer-to-peer, and human-machine interface (HMI) connectivity at high speeds and data volumes, and sometimes with redundancy capabilities.

Four of the most popular industrial Ethernet protocols are EtherNet/IP, PROFINET, EtherCAT, and Modbus TCP/IP (Modbus TCP). BACnet is widely used in the HVAC industry. VFDs with one or more of these protocols built in, or available as options, provide an advantage for more sophisticated systems with PLC and other controllers.

Jump to Chapter

Chapter 1
AC Motor Drive
Introduction

Chapter 2
AC Motor Control
Basics

Chapter 3
VFD Details

Chapter 4
Common Design and
Application Errors

Chapter 5
VFD Selection

Other VFD Details

So far, this eBook has addressed the most essential VFD information. However, there are many other VFD details covering a wide range of topics. The following are some suggestions with helpful links for further investigation.

Built-In PLC

By selecting a VFD with a built-in PLC, designers can create a complete standalone automation system without requiring external controllers. This can be a compact and cost-effective way to implement control, consolidating ladder logic programming and VFD motor control capabilities.

<https://library.automationdirect.com/vfds-with-integrated-plcs/>

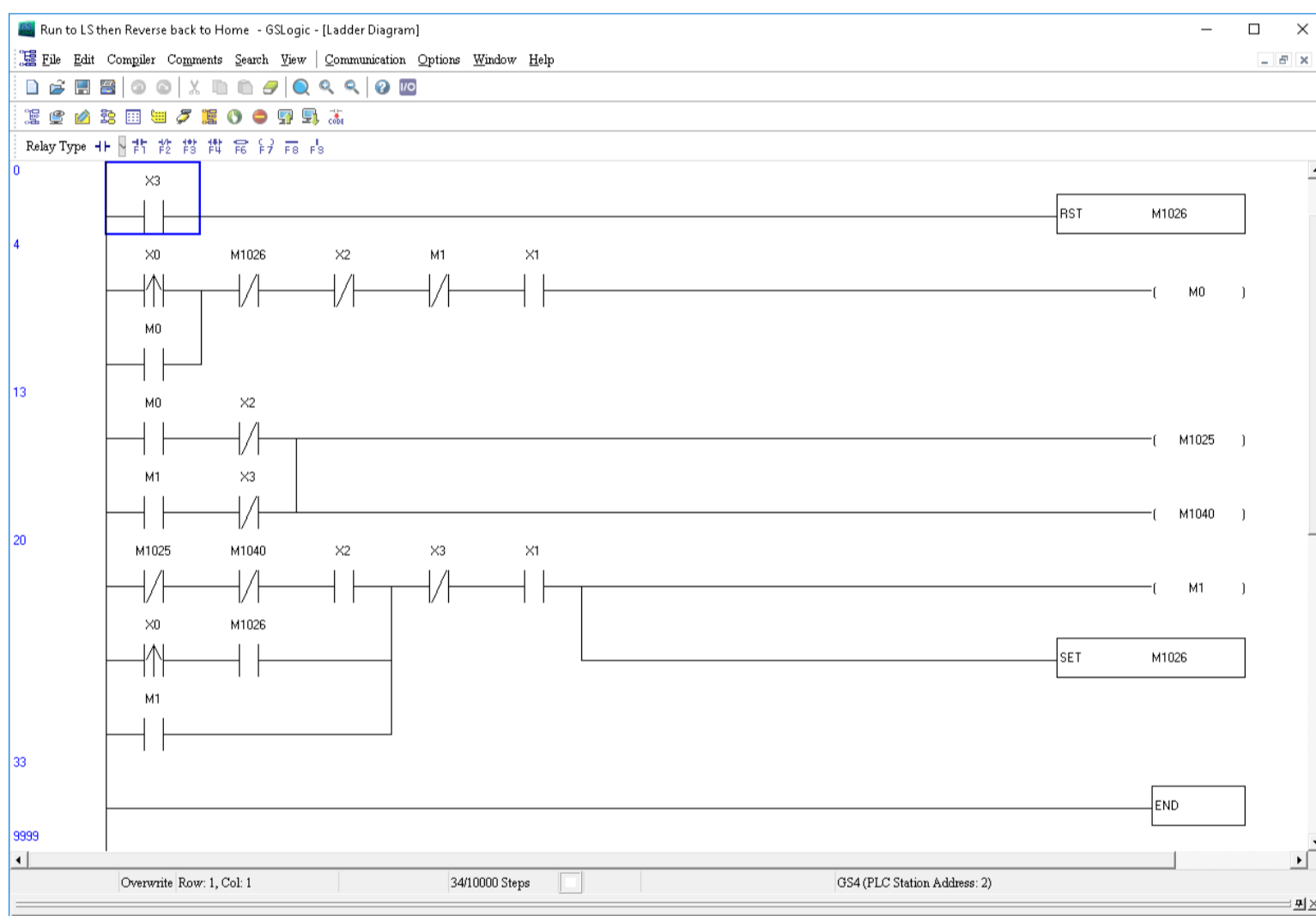

Example of a ladder logic program in the built-in PLC of a VFD.

Energy Savings

VFDs can be used to save energy by driving motors at just the required speed, which may be well below the nominal speed rating of the motor. Affinity laws, also known as “fan laws” or “pump laws,” express performance for various mechanical systems. Equipment power requirements vary as the cube of speed, so the ability to reduce motor speed to exactly what is needed can result in substantial energy savings with rapid paybacks.

<https://library.automationdirect.com/vfd-or-not-vfd/>

<https://library.automationdirect.com/get-schooled-ac-motor-basics/>

Jump to Chapter

Chapter 1
AC Motor Drive
Introduction

Chapter 2
AC Motor Control
Basics

Chapter 3
VFD Details

Chapter 4
Common Design and
Application Errors

Chapter 5
VFD Selection

Keypads

Most VFDs include an on-board keypad interface, providing an HMI for users to visualize, control, and configure the device. Some keypads are removable, and some can facilitate configuring multiple drives. Many VFDs also offer the option of mounting a remote keypad to the outside of an enclosure, allowing safer access.



Proportional/Integral Derivative (PID) Control

The PID algorithm is commonly used to perform continuous regulatory control. For VFD-driven motors, a PID control loop can vary the motor speed as needed to maintain a target process flow, level, pressure, or other characteristic. PID control can be achieved with a dedicated device or another external controller, such as a PLC. However, many VFDs include powerful on-board PID control algorithms.



Safety Functions

As noted earlier, a VFD may include built-in safety features such as safe torque off (STO) and safe stop 1 (SS1). Designers can use these features to prevent unexpected motor operation even when the VFD is connected to a power source or to bring the driven motor to a controlled safe stop.



Jump to Chapter

Chapter 1
AC Motor Drive
Introduction

Chapter 2
AC Motor Control
Basics

Chapter 3
VFD Details

Chapter 4
Common Design and
Application Errors

Chapter 5
VFD Selection

Power Quality

Because VFDs are solid state devices using PWM waveforms, they can impact the power quality both upstream and downstream of the VFD by producing electromagnetic interference (EMI), noise, and harmonics. To address this, AutomationDirect offers line reactors, output filters, and EMI filters.

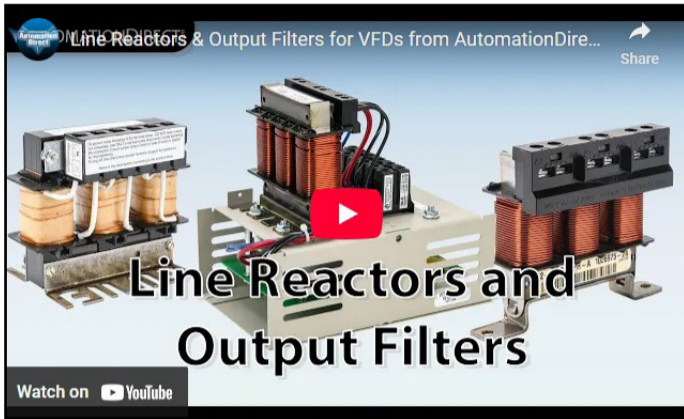

Configuration, Monitoring, and Troubleshooting Software

AutomationDirect realizes the valuable role of capable yet easy-to-use software, so users can conveniently and rapidly configure VFDs, monitor them during commissioning and operation, and troubleshoot them when necessary. AutomationDirect offers free VFD software with intuitive interfaces.

<https://www.automationdirect.com/support/software-downloads>

See how easy it is to configure and monitor an IronHorse VFD with the VFD Suite Configuration Software.

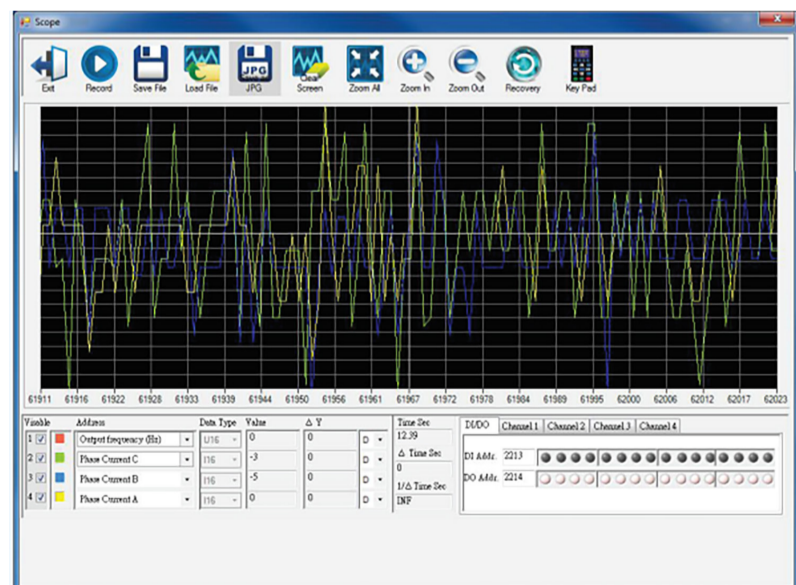
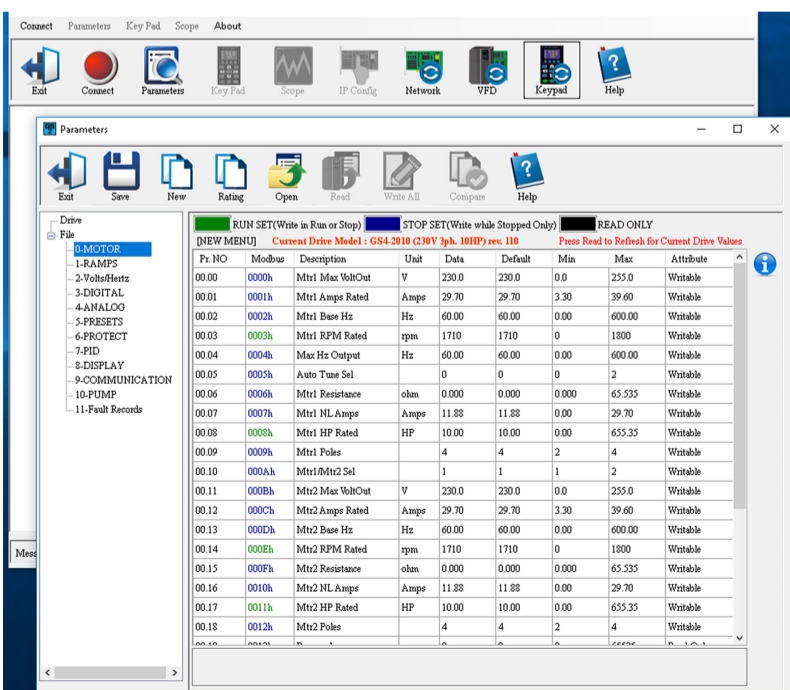
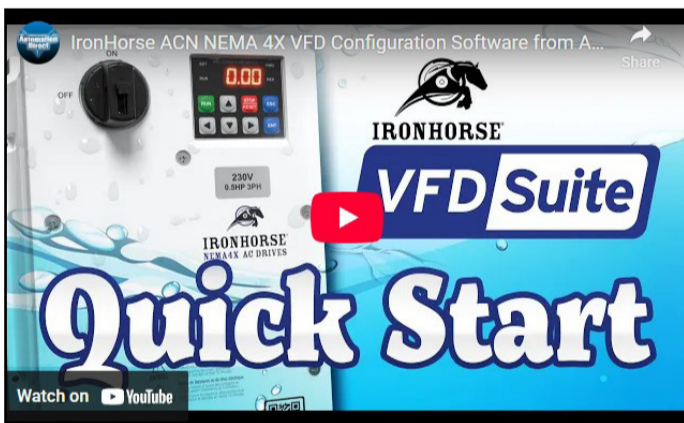

Convenient software tools, including a parameter dialog and scope window.

Jump to Chapter

Chapter 1
AC Motor Drive Introduction

Chapter 2
AC Motor Control Basics

Chapter 3
VFD Details

Chapter 4
Common Design and Application Errors

Chapter 5
VFD Selection

Other Accessories

AutomationDirect offers many accessories for mounting, connecting, and otherwise implementing VFDs. Check out some options at the following link:

<https://www.automationdirect.com/VFD>

The screenshot shows the AutomationDirect website's 'VFD Accessories' page. The page features a navigation bar with the company logo, search bar, and account options. Below the navigation, there are filters for 'Item Type' and 'Brand Name'. The main content area is titled 'Accessories for AC Variable Frequency Drives' and lists various product categories: Micro VFDs, General Purpose VFDs, High-Performance VFDs, Washdown (NEMA 4X) VFDs, VFD Communication & I/O Modules, VFD Accessories (156), Line Reactors & Output Filters, Braking Units & Resistors, and EMI Filters. A table of 156 products is displayed, with the 'IronHorse GSD series speed potentiometer kit, replacement, output up to input voltage, 5k ohm, 0.5W. For use with all GSD series DC drives. Includes potentiometer, knob, 0-100% dial and mounting hardware.' (GSDA-5K) highlighted. The price is \$22.00, and 80 units are available. The product has a 5.0 star rating and a 'Product Score (5.0)'. A 'Chat with an Agent' button is visible in the bottom right corner.

Jump to Chapter

Chapter 1
AC Motor Drive
Introduction

Chapter 2
AC Motor Control
Basics

Chapter 3
VFD Details

Chapter 4
Common Design and
Application Errors

Chapter 5
VFD Selection

Common Design and Application Errors

Modern ACVFDs are incredibly flexible and remarkably easy to specify, configure, and operate. That being said, there are a handful of issues users should be aware of when selecting and implementing VFDs.

Improper Sizing

It can be tempting to exactly match the VFD size to the motor load, and in many cases, this is appropriate. However, designers must understand the complete application and potential motor overload conditions, as VFDs must sometimes be upsized. Additionally, it can be useful to oversize some VFDs in a multi-VFD application to minimize the variety of sizes used, improving maintainability and minimizing required spare parts.

Improper Cooling and Ventilation

Closely related to electrically sizing a VFD is the need to evaluate the thermal characteristics of the installation. VFD enclosures that are too small or located in unfavorable ambient conditions can cause drives to become overheated, resulting in temperature faults. Some VFDs are rated for zero-stack side-by-side installation, but it is always important to follow the installation and spacing orientation requirements for every VFD.

When designing an enclosure to contain VFDs—refer to these links for [IP and NEMA ratings](#) and [this white paper](#) on enclosure selection—designers must add up the watts (heat) generated by all components within the enclosure and evaluate this with the ambient environment to determine what thermal management technologies are required, such as vent fans, heat exchangers, or air conditioning. In some extreme cold applications, a heater may be required. Many industrial manufacturers [offer calculation tools](#) to assist with these design efforts.

Lack of Dynamic Braking

Loads that stop quickly, or even steady-speed loads with high inertia, can lead to electrical regeneration, resulting in [DC bus overvoltage trips](#). If these conditions are recognized during the design phase—or, unfortunately, spotted in operation—then applying a braking resistor and dynamic braking is likely needed.

Communication Issues

While many VFDs are still implemented as standalone devices or with only basic hardwired I/O signals, Ethernet communication protocols are becoming more mainstream, thanks to readily available industrial protocols. While Ethernet has become the communications methodology of choice for a variety of applications, designers must choose the proper protocol, cabling, installation methods, and grounding practices to ensure reliability. For VFD applications, the output cables to the motor are electrically noisy, and running improperly shielded communications cables too close to power conductors can lead to intermittent or constant communications noise.

Jump to Chapter



Chapter 1

AC Motor Drive Introduction

Chapter 2

AC Motor Control Basics

Chapter 3

VFD Details

Chapter 4

Common Design and Application Errors

Chapter 5

VFD Selection

Ground Fault Errors

Ground faults—where a portion of the motor conductors makes an unintentional connection to ground, causing some current to flow to ground—can be an issue with any motor installation and lead to equipment damage as well as safety hazards. For across-the-line starters, ground faults may go undetected unless special monitoring provisions are in place. However, because VFDs have phase current sensors, they can detect ground fault conditions and will trip accordingly. Diagnosing ground faults requires checking the VFD, motor leads, and the motor itself. Note that it is vital to follow the manufacturer's recommendations for grounding connections of the VFD. Many times, an improper ground connection can cause nuisance ground fault errors.

Improper Line Voltage

Sagging or noisy line voltage supplied to a VFD can lead to undervoltage trips. If improper line voltage is suspected, it may be necessary to install monitoring equipment to identify and rectify the issue. Some less-common site power supplies, notably 230VAC high-delta, may cause similar problems with VFDs.

Poor PID Tuning or Control Logic

Some VFDs have powerful PID loop and control logic functions built in, or they may be controlled by a PLC or other controller. In either case, a poorly tuned PID loop or flawed control logic can command the VFD to operate erratically and may result in unexpected fault conditions. While the problem may seem to be VFD-centric, the root cause is often in the onboard or external control logic, requiring careful troubleshooting to isolate.

Jump to
Chapter 

Chapter 1

AC Motor Drive
Introduction

Chapter 2

AC Motor Control
Basics

Chapter 3

VFD Details

Chapter 4

Common Design and
Application Errors

Chapter 5

VFD Selection

VFD Selection

Selecting the appropriate motors, drives, controllers, and more for a complete motor control solution can be daunting. AutomationDirect understands the challenge, and in addition to assembling a wide-ranging portfolio of products, we have created many user-friendly online resources to help guide the process.

Here are a few helpful selection guide links:

<https://cdn.automationdirect.com/static/catalog/images/product-pdf/driveselection.pdf>



Here are some drive application stories:

<https://library.automationdirect.com/vfds-keep-good-time-pumping/>

<https://library.automationdirect.com/automating-a-luxury-bus/>

<https://library.automationdirect.com/turning-up-the-heat-balky-boiler/>

<https://library.automationdirect.com/recipe-for-automation-success/>

Jump to Chapter

Chapter 1
AC Motor Drive
Introduction

Chapter 2
AC Motor Control
Basics

Chapter 3
VFD Details

Chapter 4
Common Design and
Application Errors

Chapter 5
VFD Selection